

**PLAN**

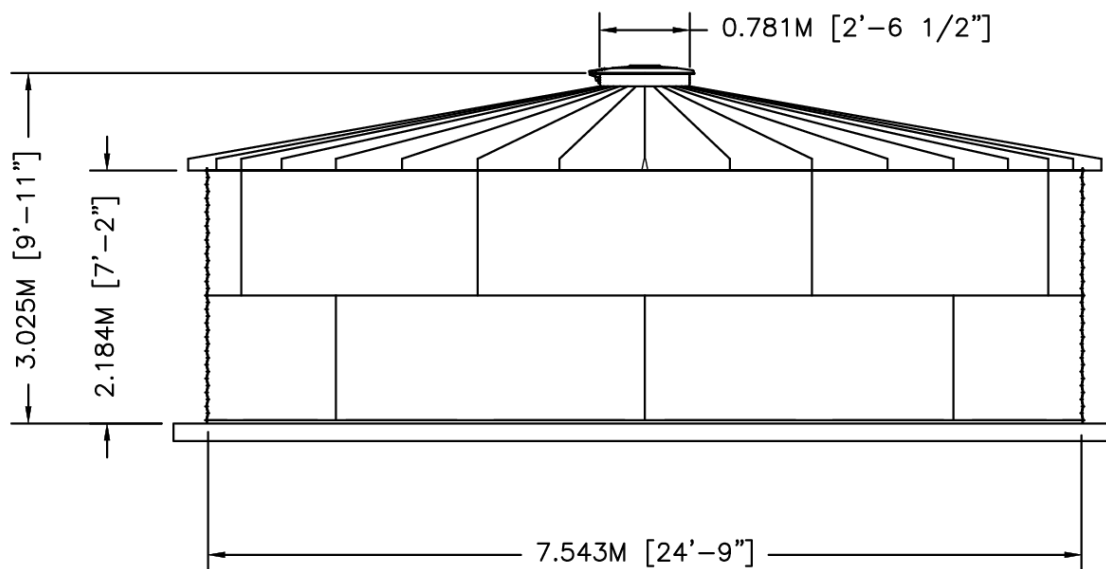

**ELEVATION**



	BY	DATE	TITLE	
DWN	XXX	XX/XX/XX	WTU08-02 30"PR 10DEG V-RIB	
CKD			NOMINAL CAPACITY - 91.948 M3 [24,290 GAL]	
ENG			DWG. NO. SCT2402-LVR WTU08-02	REV. NO.
			SIZE: A	SCALE: 3/16"=1'-0"
			SHEET 1	OF 1